

Memorex[®]

**SPLASH-RESISTANT AM/FM STEREO
RADIO WITH COMPACT DISC PLAYER**

MODEL: MC1003

**BEFORE OPERATING THIS PRODUCT, PLEASE READ THESE
INSTRUCTIONS COMPLETELY.**

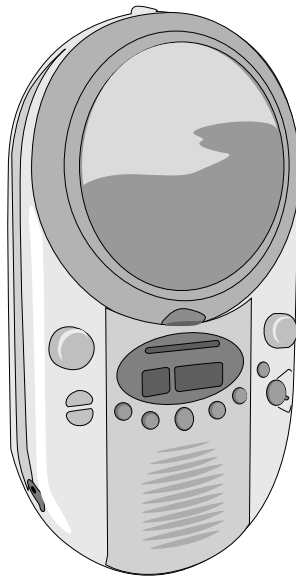

OPERATING INSTRUCTIONS

SAFETY PRECAUTIONS

Thank you for purchasing the Memorex audio system.

The serial number of your unit can be found on a label on the rear of the cabinet. We suggest that you record the serial number in the space provided below in case this information is ever needed at a future date.

PLEASE KEEP ALL PACKAGING MATERIAL FOR AT LEAST 90 DAYS IN CASE YOU NEED TO RETURN THIS PRODUCT TO YOUR PLACE OF PURCHASE OR MEMOREX.

Model Number: MC1003

Serial Number: _____

SPLASH RESISTANT: DO NOT use this unit under direct water flow. This unit is splash resistant, meaning it can withstand small splashes of water.



CAUTION
RISK OF ELECTRIC SHOCK
DO NOT OPEN



CAUTION: TO REDUCE THE RISK OF ELECTRIC SHOCK, DO NOT REMOVE COVER (OR BACK). NO USER-SERVICEABLE PARTS INSIDE. REFER SERVICING TO QUALIFIED SERVICE PERSONNEL.



DANGEROUS VOLTAGE

Uninsulated Dangerous Voltage, that may be of sufficient magnitude to constitute a risk of electric shock to persons is present within this product's enclosure.



ATTENTION

The Owner's Manual contains important operating and maintenance instructions.

For your safety, it is necessary to refer to the manual.

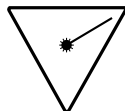

DANGER:

Invisible and hazardous laser radiation when open and interlock failed or defeated. Avoid direct exposure to beam.

SAFETY PRECAUTIONS (CONTINUED)

FCC WARNING:

This equipment may generate or use radio frequency energy. Changes or modifications to this equipment may cause harmful interference unless the modifications are expressly approved in the instruction manual. The user could lose the authority to operate this equipment if an unauthorized change or modification is made.

LASER SAFETY: This unit employs a laser. Only qualified service personnel should attempt to service this device due to possible eye injury.

CAUTION: USE OF CONTROLS, ADJUSTMENTS OR PERFORMANCE PROCEDURE HEREIN MAY RESULT IN HAZARDOUS RADIATION EXPOSURE.

INFORMATION:

This equipment has been tested and found to comply with the limits for a Class B digital device, pursuant to Part 15 of the FCC Rules. These limits are designed to provide reasonable protection against harmful interference in a residential installation. This equipment generates, uses, and can radiate radio frequency energy and, if not installed and used in accordance with the instructions, may cause harmful interference to radio communications. However, there is no guarantee that interference will not occur in a particular installation. If this equipment does cause harmful interference to radio or television reception, which can be determined by turning the equipment off and on, the user is encouraged to try to correct the interference by one or more of the following measures:

- Reorient or relocate the receiving antenna.
- Increase the separation between the equipment and receiver.
- Connect the equipment into an outlet on a circuit different from that to which the receiver is connected.
- Consult the dealer or an experienced radio/TV technician for help.

SAFETY PRECAUTIONS (CONTINUED)

- Do not open the CD compartment while the CD is rotating.
- Always keep the CD compartment closed when not in use.
- Keep all foreign objects out of the CD compartment.
- Place the unit on a stable surface.
- Avoid installing the unit in locations described below:
 - Places exposed to direct sunlight or close to heat radiating appliances such as electric heaters.
 - On top of other stereo equipment that radiates too much heat.
 - Placed lacking ventilation or dusty places.
 - Places subject to constant vibration.
 - Humid or moist places.

Dear Customer:

Selecting fine audio equipment such as the unit you've just purchased is only the start of your musical enjoyment. Now it's time to consider how you can maximize the fun and excitement your equipment offers. This manufacturer and the Electronic Industries Association's Consumer Electronics Group want you to get the most out of your equipment by playing it at a safe level. One that lets the sound come through loud and clear without annoying blaring or distortion and, most importantly, without affecting your sensitive hearing.

Sound can be deceiving. Over time your hearing "comfort level" adapts to higher volumes of sound. So what sounds "normal" can actually be loud and harmful to your hearing. Guard against this by setting your equipment at a safe level BEFORE your hearing adapts.

To establish a safe level:

- Start your volume control at a low setting.
- Slowly increase the sound until you can hear it comfortably and clearly, and without distortion.

Once you have established a comfortable sound level:

- Set the dial and leave it there.

Taking a minute to do this now will help to prevent hearing damage or loss in the future. After all, we want you listening for a lifetime.

We Want You Listening For A Lifetime

Used wisely, your new sound equipment will provide a lifetime of fun and enjoyment. Since hearing damage from loud noise is often undetectable until it is too late, this manufacturer and the Electronic Industries Association's Consumer Electronics Group recommend you avoid prolonged exposure to excessive noise. This list of sound levels is included for your protection.

Decibel

<u>Level</u>	<u>Example</u>
30	Quiet library, soft whispers
40	Living room, refrigerator, bedroom away from traffic
50	Light traffic, normal conversation, quiet office
60	Air conditioner at 20 feet, sewing machine
70	Vacuum cleaner, hair dryer, noisy restaurant
80	Average city traffic, garbage disposals, alarm clock at two feet

THE FOLLOWING NOISES CAN BE DANGEROUS UNDER CONSTANT EXPOSURE:

90	Subway, motorcycle, truck traffic, lawn mower
100	Garbage truck, chain saw, pneumatic drill
120	Rock band concert in front of speakers, thunderclap
140	Gunshot blast, jet engine
180	Rocket launching pad

Information courtesy of the Deafness Research Foundation.



LOCATION OF CONTROLS

MAIN

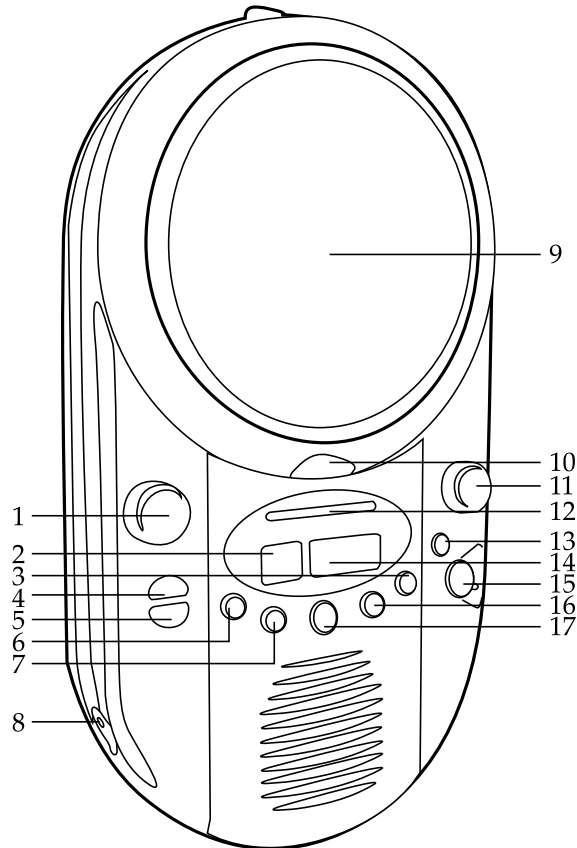

- | | |
|--------------------------|----------------------------------|
| 1. VOLUME/POWER Control | 10. CD Door OPEN Button |
| 2. CD Track Display | 11. TUNING Control |
| 3. SKIP/Search ►► Button | 12. AM/FM Dial Scale and Pointer |
| 4. MODE Button | 13. PROGRAM Button |
| 5. SET Button | 14. Clock Display |
| 6. REPEAT Button | 15. Function Switch |
| 7. STOP (■) Button | 16. SKIP/Search ◀◀ Button |
| 8. Headphone Jack | 17. PLAY/PAUSE (▶) Button |
| 9. Mirror/CD Compartment | |

LOCATION OF CONTROLS (CONTINUED)

REAR

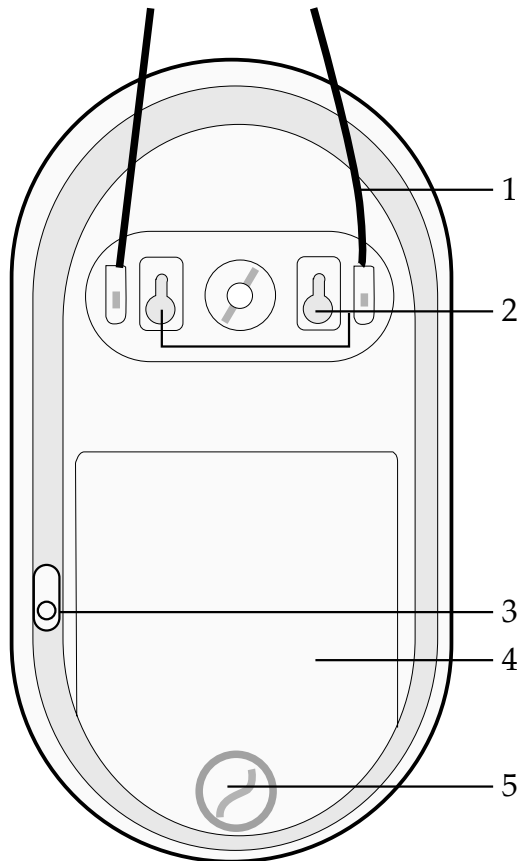

1. Hanging Cord
2. Wall Mount Holes
3. DC 9V Jack \ominus — \oplus
4. Battery Compartment
5. Battery Door Locking Knob

INSTALLATION

SPLASH RESISTANT: DO NOT use this unit under direct water flow. This unit is splash resistant, meaning it can withstand small splashes of water.

MOUNTING THE UNIT ON THE BASE

To use this unit with the supplied base, simply slide the hole on the rear of the unit into the hook on the base and gently push it backwards so it snaps in place as shown in figure 1.

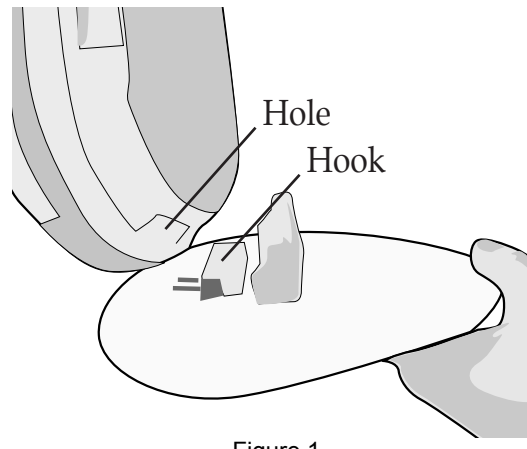

Figure 1

REMOVING THE UNIT FROM THE BASE

To remove unit from base, simply press in on the tab located at the bottom of the base and lift up the unit as shown in figure 2.

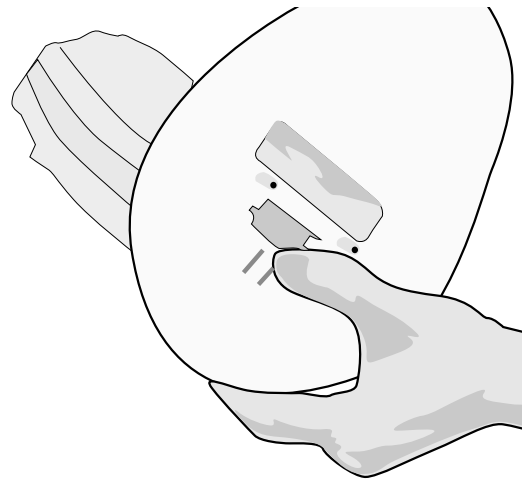

Figure 2

USING THE HANGING CORD (No Figure):

Use the Hanging Cord to hang the unit on an already installed hook, nail, etc. When using the Hanging cord, also use the Wall Adapter for extra support.

INSTALLATION (CONTINUED)

INSTALLING ON A WALL

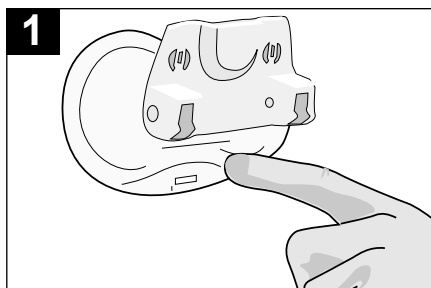

1 Put the Wall Adapter with suction cups on the wall.

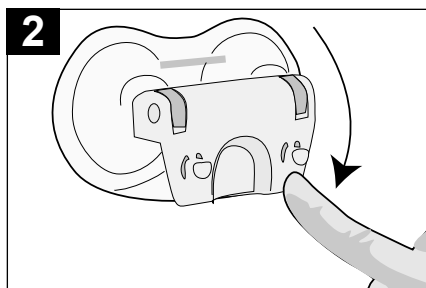

2 Pull the suction cup lever down and it will stick to the wall.

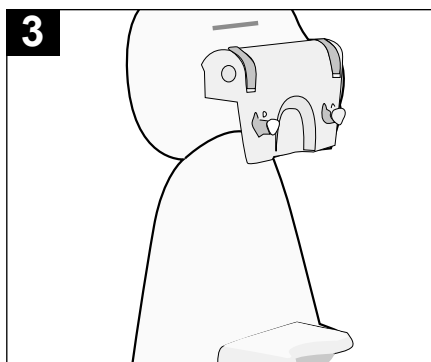

3 Place the Detachable Mounting Bracket onto the Wall Adapter.

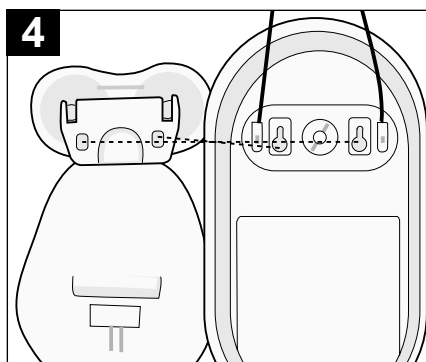

4 Connect the main unit to the Wall Adapter by inserting the holes on the base unit into the hooks on the Wall Adapter.

REMOVAL

To remove, reverse the above steps.

IMPORTANT CAUTION

Make sure the suction cups are secured on the wall every two to three weeks.

HEADPHONE JACK:

Plug headphones with a 3.5mm plug into this jack for private listening.

POWER SOURCES

This CD player requires either eight (8) "C" cell batteries (not included) or a 9V AC adapter having a positive center.

BATTERY INSTALLATION

1. Make sure the unit is not on the base. Open the battery compartment door by rotating the Battery knob clockwise, then lift the battery compartment off.
2. Insert eight (8) "C" cell batteries (not included) as shown in the illustration to the right. Alkaline batteries are recommended for the longest playing time.
3. Replace the battery compartment cover and rotate the Battery knob counter-clockwise so the compartment is secured.

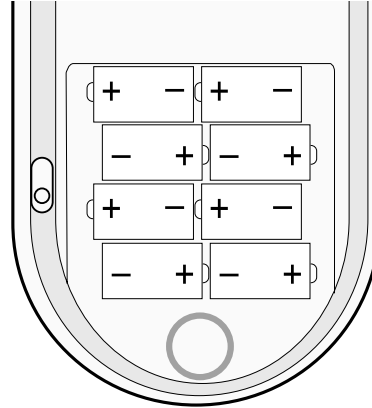

BATTERY PRECAUTIONS

Follow these precautions when using batteries in this device:

1. Use only the size and type of batteries specified.
2. Be sure to follow the correct polarity when installing the batteries as indicated next to the battery compartment. Reversed batteries may cause damage to the device.
3. Do not mix different types of batteries together (e.g. Alkaline and Carbon-zinc) or old batteries with fresh ones.
4. If the device is not to be used for a long period of time, remove the batteries to prevent damage or injury from possible battery leakage.
5. Do not try to recharge batteries not intended to be recharged; they can overheat and rupture. (Follow battery manufacturer's directions.)

AC OPERATION

To operate the unit using AC power, connect an adapter with an input of 120V, 60Hz and an output of 9V DC, 500mA (**adapter not included**) to an AC outlet having 120V, 60Hz AC only. Plug the small end into the DC 9V jack on the unit and connect the other end into the AC outlet. The batteries are automatically disconnected when the AC adapter is used.

CAUTION: When not using AC power, disconnect the AC adapter from the wall outlet by pulling the plug (not the cord). Do not touch the AC adapter with wet hands and plug fully inserted without exposing any part of the blade. Do not use an AC adapter near water.

OPERATION

FOGLESS MIRROR

Before using, remove the thin film over the fogless mirror and discard.

CLEANING THE MIRROR

If the mirror, which is made of polycarbonate (plastic), becomes dirty or smudged with fingerprints, it may be cleaned with a wet soft cloth. Never use abrasive cloths or polishes as these will mar the finish of the mirror.

TO PLAY THE RADIO

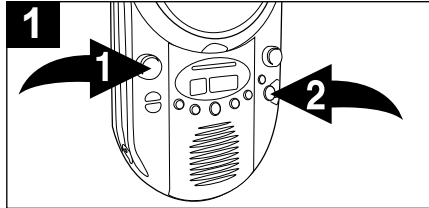

Rotate the VOLUME/POWER control ❶ clockwise until a click is heard to turn the unit on. Turn the Function switch ❷ to the desired band (AM or FM).

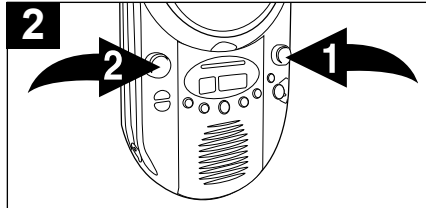

Tune a station by rotating the TUNING control ❶. Adjust the VOLUME/POWER control ❷ as desired.

Antennas

Turn the unit for best AM/FM reception.

TO INSERT A CD

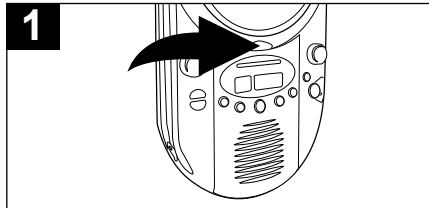

Open the CD Compartment Door by pressing up on the CD Door OPEN button. Gently push a disc, label side up, onto the spindle until it locks in place and close the CD Compartment Door.

TO REMOVE A CD

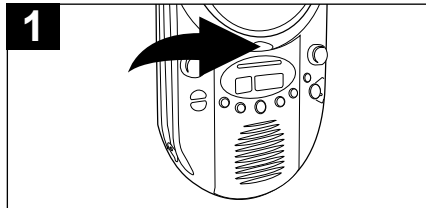

Make sure the CD has stopped and open the CD Compartment Door by pressing up on the CD Door OPEN button. Hold the edge of the CD and pick it up. Close the CD Compartment Door.

OPERATION (CONTINUED)

TO PLAY A CD

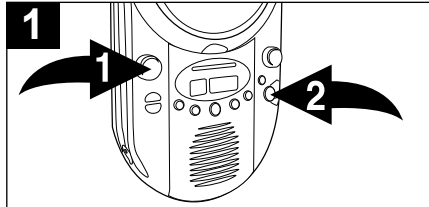

Rotate the VOLUME/POWER control ❶ clockwise until a click is heard to turn the unit on. Turn the Function switch ❷ to the CD position.

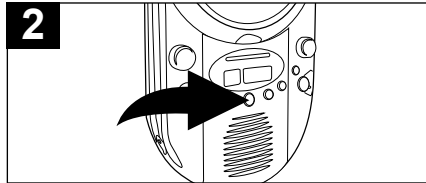

Insert a CD as described on the previous page and press the PLAY/PAUSE (▶||) button to start playback.

TO PAUSE PLAYBACK, press the PLAY/PAUSE (▶||) button again; PLAY will blink in the display. Press the PLAY/PAUSE (▶||) button again to resume playback.

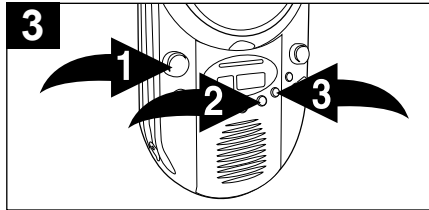

Adjust the VOLUME/POWER ❶ as desired. To **skip** forward or backward through the tracks on the disc, press the SKIP/Search ◀◀ ❷ or ▶▶ ❸ button. To **search** forward or backward through the tracks on the disc, press and hold the SKIP/Search ◀◀ ❷ or ▶▶ ❸ button.

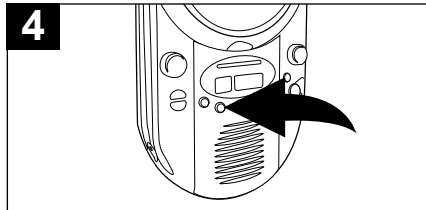

When the disc is through playing, it will stop. Press the STOP (■) button to stop the disc before it is finished.

NOTES:

- This unit is capable of playing standard CDs or 3" singles; no adapter is required.
- If a disc is inserted incorrectly, dirty, damaged or not present at all, the disc will not play and "disc" will appear in the display.
- To remove the disc, open the CD Compartment, hold the edge of the CD and lift it out.
- The maximum time of a CD is 74 minutes for this unit.

OPERATION (CONTINUED)

TO REPEATEDLY PLAY BACK ONE TRACK

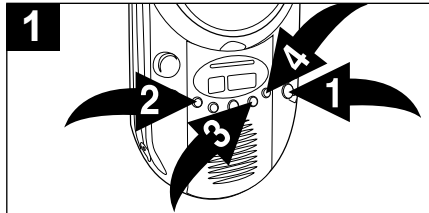

1 Turn the unit on and turn the Function switch ❶ to the CD position. Press the REPEAT button ❷ once; RPT will blink in the display. Select a track using the SKIP/Search ◀❸ or ▶❹ buttons.

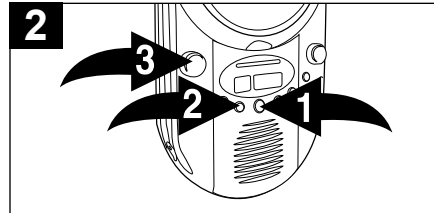

2 Press the PLAY/PAUSE (▶||) button ❶. The unit will then play the same track over and over until the STOP (■) button ❷ is pressed. Adjust the VOLUME/POWER control ❸ as desired.

TO REPEATEDLY PLAY BACK ALL TRACKS ON A CD

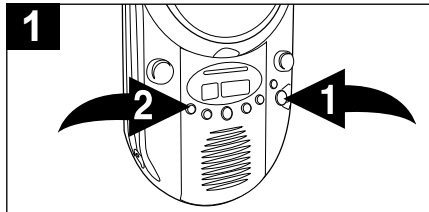

1 Turn the unit on and turn the Function switch ❶ to the CD position. Press the REPEAT button ❷ twice; RPT will light solid in the display.

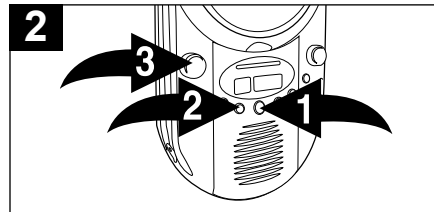

2 Press the PLAY/PAUSE (▶||) button ❶. The unit will then play all the tracks on the CD over and over until the STOP (■) button ❷ is pressed. Adjust the VOLUME/POWER control ❸ as desired.

TO CANCEL REPEAT PLAYBACK

To cancel Repeat playback, repeatedly press the REPEAT button until the RPT indicator disappears in the display.

OPERATION (CONTINUED)

TO PROGRAM THE MEMORY (UP TO 20 TRACKS)

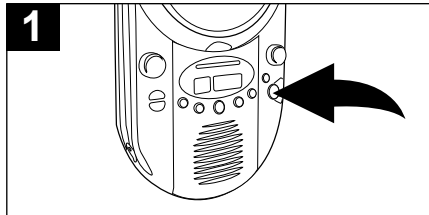

1 Turn the unit on and turn the Function control to the CD position.

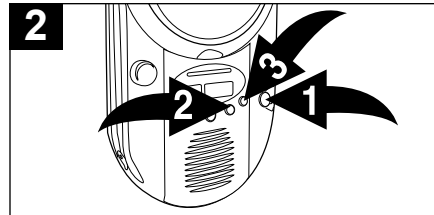

2 Press the PROGRAM button ❶, "PRG" and "01" will blink in the display. Press the SKIP/Search ❷ or ❸ button repeatedly to select the first desired track to program. Press the PROGRAM button ❶ to memorize the track.

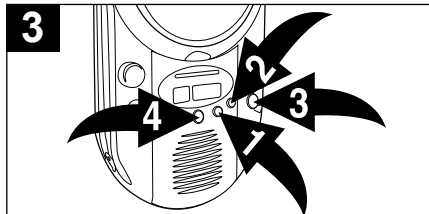

3 Press the SKIP/Search ❶ or ❷ button repeatedly to select the second desired track to program. Press the PROGRAM button ❸ to memorize the track. Repeat this step to program additional tracks up to a maximum of 20 tracks. Press the PLAY/PAUSE (❹) button to begin program playback.

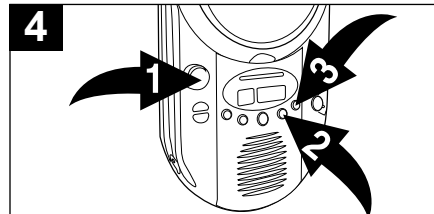

4 Adjust the VOLUME/POWER control ❶ as desired. To skip forward or backward through the programs, press the SKIP/Search ❷ or ❸ button. When the disc is through playing, it will stop.

- NOTES:**
- Press the STOP (■) button to stop the disc before it is finished.
 - As each program is played, the track number is shown in the display.
 - Programming is the ability to preselect the order in which a series of tracks will be played.
 - To cancel Program memory, while in the Stop mode mode press the STOP button until "PRG" disappears from the display.
 - Each track may be stored in the program memory as many times as desired (up to 20 tracks).
 - Repeat playback can be used in conjunction with program playback.

OPERATION (CONTINUED)

TO SET OR RESET THE ACTUAL TIME

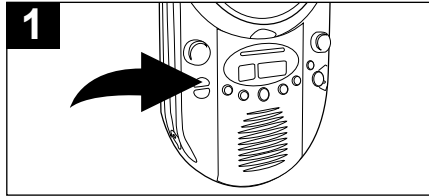

Press the MODE button four times; the month will appear in the display.

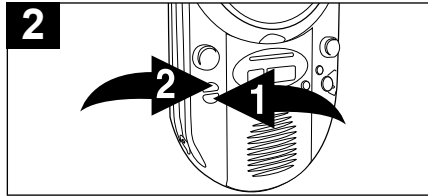

Repeatedly press the SET button ❶ to set the current month, then press the MODE button ❷ to confirm; the day will appear in the display.

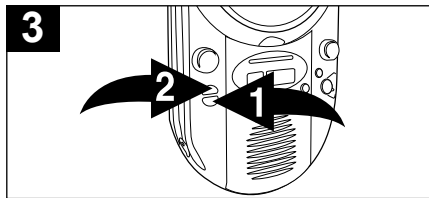

Repeatedly press the SET button ❶ to set the current day, then press the MODE button ❷ to confirm; the current hour will appear in the display.
Repeatedly press the SET button ❶ to set the current hour, then press the MODE button ❷ to confirm; the current minute will appear in the display.

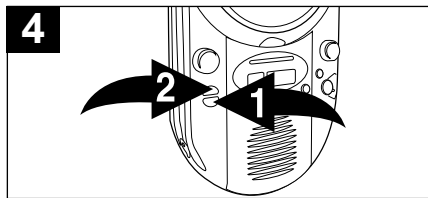

Repeatedly press the SET button ❶ to set the current minute, then press the MODE button ❷ to confirm, then press the SET button ❶ to exit.

OPERATION (CONTINUED)

TO SET OR RESET THE ALARM TIME

Please note that the alarm will be a beeping sound for 30 seconds. The alarm cannot be set to turn on to the radio.

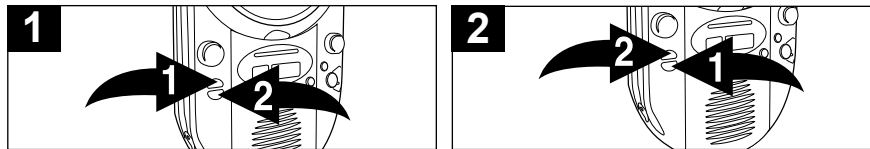

1 Press the MODE button **1** twice; the alarm time hour will blink. Repeatedly press the SET button **2** to set the alarm hour, then press the MODE button **1** to confirm; the alarm minute will appear in the display.

2 Repeatedly press the SET button **1** to set the alarm minute, then press the MODE button **2** to confirm and exit.

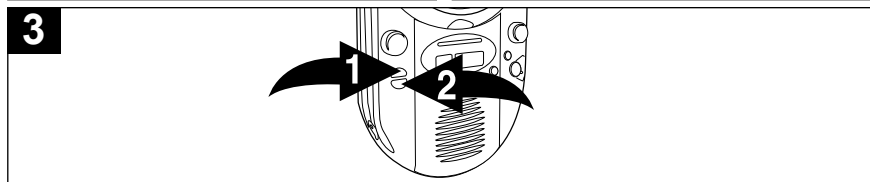

3 Press the MODE button **1** once; the alarm time will blink in the display. Press the SET button **2** repeatedly to turn on the Alarm, Beep and/or Snooze features as follows (see below for description of features):
 Press SET button **2** once to activate the alarm.
 Press SET button **2** twice to activate the alarm and beep feature.
 Press SET button **2** three times to activate the alarm, beep and snooze features.
 Press SET button **2** four times to activate the beep feature only.
 Press SET button **2** five times to activate the alarm and snooze feature.
 Press SET button **2** six times to turn all features off.
 Press the MODE button **1** three times to confirm setting.

DESCRIPTION OF FEATURES (ALARM, BEEP AND SNOOZE)

ALARM: When the alarm is activated (Alarm indicators will appear), the alarm will sound for 30 seconds then turn off when the alarm time matches the current time.

BEEP: When the beep is activated (Beep indicator will appear), a beep will be heard every hour (i.e. 1:00, 9:00, etc.).

SNOOZE: When the snooze is activated (Snooze indicator will appear), the alarm will turn off for eight minutes and then turn on again. See next page for detailed description of the Snooze feature.

IMPORTANT SAFETY INSTRUCTIONS

TO SHUT OFF THE ALARM

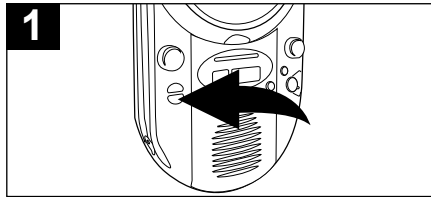

To turn off the alarm while it is sounding, press the SET button. The alarm will stop and be set for the next day.

CHECKING TIMES/DATE

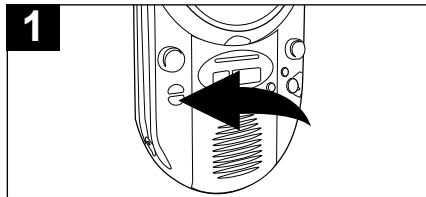

Press the SET button once while in the actual time mode to check the alarm time, twice to check the date and three times to check the seconds. While checking the alarm or date, the unit will revert back to the actual time mode after three seconds. When checking the seconds, you must press the SET button again to return to the actual time.

TO USE THE SNOOZE FEATURE

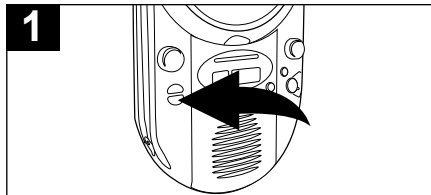

Activate the Snooze feature as described on the previous page. When the alarm sounds, press the SET button **within 30 seconds**; the alarm will turn off for eight minutes and then turn on again. If the SET button is not pressed within 30 seconds, the alarm will just turn off.

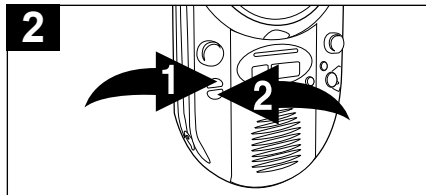

To cancel the Snooze feature, press the MODE button ❶ once, then the SET button ❷ repeatedly until the indicators disappear from the display.

TROUBLESHOOTING GUIDE

If you experience a problem with this unit, check the chart below before calling for service.

SYMPTOM	CAUSE	SOLUTION
Unit will not turn on.	Weak or dead batteries.	Replace batteries.
	Wrong adapter being used	Use only center positive adapter with 9V output.
	AC adapter not connected.	Check AC adapter connection.
Disc will not play.	CD compartment not closed.	Close CD compartment.
	Disc inserted incorrectly.	Reinsert disc correctly.
	Dirty or defective disc.	Try another disc.
	Moisture condensation on disc.	Wipe disc with soft cloth.
Erratic CD playback.	Dirty or defective disc.	Clean or replace disc.
No sound.	Headphone plug inserted into headphone jack.	Unplug headphones.
	VOLUME/POWER control set to minimum.	Increase volume.
	Weak batteries.	Replace batteries.
	Defective disc.	Try another disc.
	Function is not set to the desired position.	Turn the FUNCTION switch to the desired function.
Noise or sound distorted on radio.	Station not tuned properly for AM or FM.	Retune AM or FM broadcast station.
	Unit is not positioned correctly.	Rotate unit until best reception is obtained.
Alarm does not sound.	Alarm not activated.	Activate alarm.

CARE AND MAINTENANCE

Caring for Compact Discs

- Treat the compact disc carefully. Handle the compact disc only by its edges. Never allow your fingers to come in contact with the shiny, unprinted side of the compact disc.
- Do not attach adhesive tape, stickers, etc. to the compact disc label.
- Clean the compact disc periodically with a soft, lint-free, dry cloth. Never use detergents or abrasive cleaners to clean the compact disc. If necessary, use a CD cleaning kit.
- If a compact disc skips or gets stuck on a section of the compact disc, it is probably dirty or damaged (scratched).
- When cleaning the compact disc, wipe in straight lines from the center of the compact disc to the outer edge of the compact disc. Never wipe in circular motions.

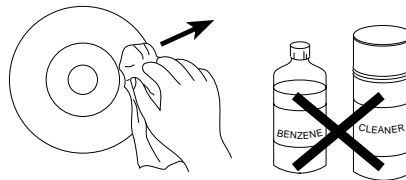
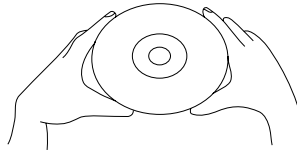

- Compact discs should be stored in their cases after each use to avoid damage.
- Do not expose compact discs to direct sunlight, high humidity, high temperatures, or dust, etc. Prolonged exposure or extreme temperatures can warp the compact disc.
- Do not stick or write anything on either side of the compact disc. Sharp writing instruments, or the ink may damage the surface.



Cleaning the unit

- To prevent fire or shock hazard, disconnect your unit from the AC power source when cleaning.
- The finish on your unit may be cleaned with a dust cloth and cared for as other furniture. Use caution when cleaning and wiping the plastic parts.
- Mild soap and a damp cloth may be used on the front panel.

SPECIFICATIONS

Frequency Range (FM)	87.5–108MHz
Frequency Range (AM)	530–1720kHz
Dimensions	12" (H) x 6–1/2" (W) x 3-1/4" (D)
Weight	1.4Kg

FOR ADDITIONAL SET-UP OR OPERATING ASSISTANCE, PLEASE
VISIT OUR WEBSITE AT

WWW.MEMOREXELECTRONICS.COM

OR CONTACT CUSTOMER SERVICE AT 1-800-919-3647.

PLEASE KEEP ALL PACKAGING MATERIAL FOR AT LEAST 90
DAYS IN CASE YOU NEED TO RETURN THIS PRODUCT TO YOUR
PLACE OF PURCHASE OR MEMOREX.

FOR PARTS AND ACCESSORIES, CONTACT FOX INTERNATIONAL AT
1-800-321-6993.

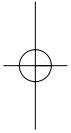

Memcorp, Inc.
Weston, FL
Printed in Hong Kong

Visit our website at www.memorexelectronics.com

